

Name: \_\_\_\_\_ Date: \_\_\_\_\_ Event: \_\_\_\_\_

Track: INDOOR  OUTDOOR  Size: SMALL  MEDIUM  LARGE  Traction: LOW  MEDIUM  HIGH

Surface: SMOOTH  BUMPY  RUTTED  Type: LOOSE / LOAMY  HARD PACKED  BLUE GROOVE  CLAY  ASTRO

Bumpsteer/Ackerman/Servo Saver/Steering Stop: \_\_\_\_\_ Condition: DUSTY  DRY  WET  MUDDY

WASHERS:

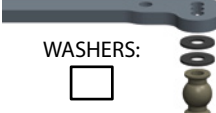

WASHERS:



FRONT OF VEHICLE

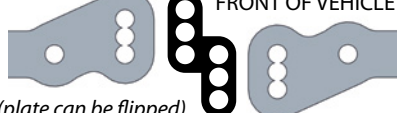

(plate can be flipped)

FULL TURNS FROM FULLY TIGHT

WASHERS:

SCREW:



## Front End:

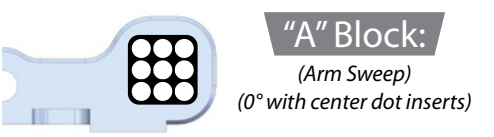
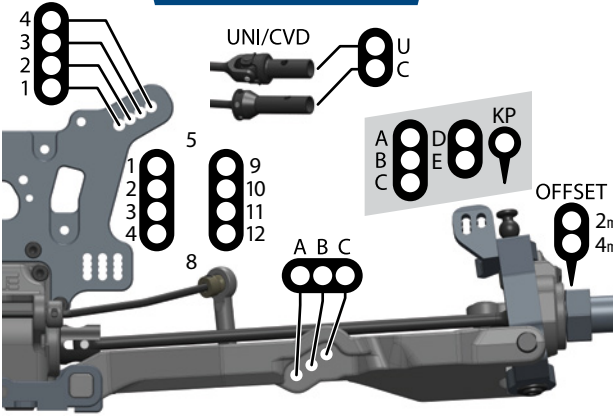

## Suspension:

RIDE HEIGHT:	CAMBER:
CASTER BLOCK:	SWEEP:
KICK UP:	TOE:
SWAY BAR:	DROOP:

### Shocks:

OIL:	BRAND:
PISTON:	SPRING:
REBOUND:	BUILD:

## Differential Oil:

FRONT	CENTER	REAR
/	/	/

## Drivetrain:

CLUTCH / SPUR:	/	(teeth)
CLUTCH SHOES:		
CLUTCH SPRINGS:		
BRAKE BIAS %:	(front)	(rear)

## Equipment:

ENGINE / PIPE:	/	
FUEL / PLUG:	/	
RX BATTERY:		
	STEERING	THROTTLE / BRAKE
SERVOs:	/	

## Chassis Braces:

REAR-SHORT:	<input type="radio"/>	REAR-LONG:	<input type="radio"/>
-------------	-----------------------	------------	-----------------------

## Tires / Wheels:

BRAND / TREAD:	
COMPOUND:	
INSERT:	
WHEEL:	
NOTES:	

## Body / Wing:

BODY MAKE:					
WING MAKE:					
WING MOUNT POSITION:					
STANDARD:	<input type="radio"/>	+ 7mm:	<input type="radio"/>	+ 12mm:	<input type="radio"/>

## Notes:

## Rear End:

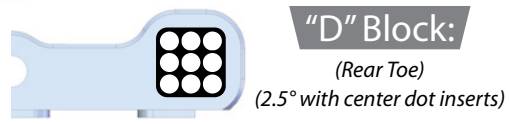
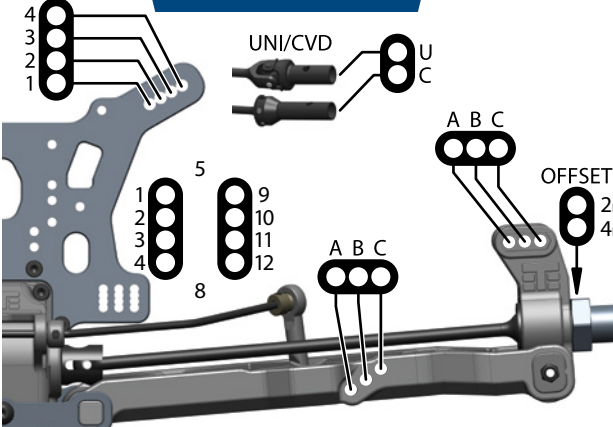

## Suspension:

RIDE HEIGHT:	CAMBER:
ANTI-SQUAT:	TOE:
SWAY BAR:	DROOP:

### Shocks:

OIL:	BRAND:
PISTON:	SPRING:
REBOUND:	BUILD:

## Arm Inserts:

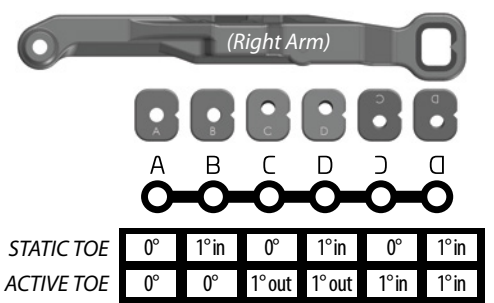

## Rear Hub / Wheelbase:

