

Name: _____ Date: _____ Event: _____

Track: INDOOR OUTDOOR Size: SMALL MEDIUM LARGE Traction: LOW MEDIUM HIGH

Surface: SMOOTH BUMPY RUTTED Type: LOOSE / LOAMY HARD PACKED BLUE GROOVE CLAY ASTRO

Bumpsteer/Ackerman/Servo Saver/Steering Stop: _____ Condition: DUSTY DRY WET MUDDY

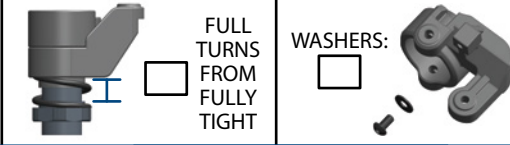
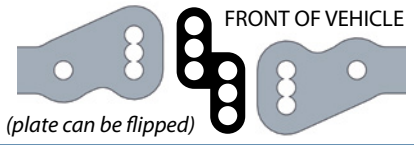
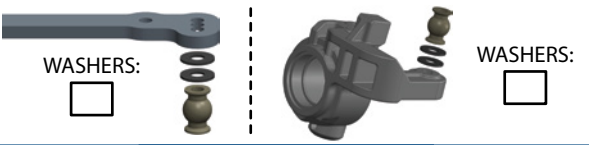

Front End:

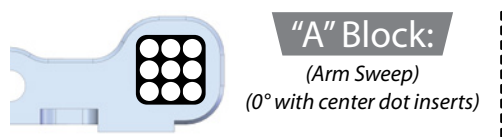
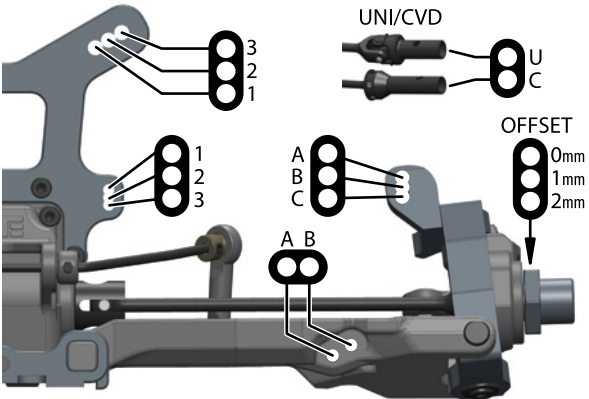

Suspension:

RIDE HEIGHT: _____ CAMBER: _____
 CASTER BLOCK: _____ SWEEP: _____
 KICK UP: _____ TOE: _____
 SWAY BAR: _____ DROOP: _____

Shocks:

OIL: _____ BRAND: _____
 PISTON: _____ SPRING: _____
 REBOUND: _____ BUILD: _____

Differential Oil:

FRONT	CENTER	REAR
/	/	/
Drivetrain:		
PINION / SPUR:	/	(teeth)
Equipment:		

ESC: _____
 BATTERY: _____
 MOTOR: _____
 SERVO: _____

Chassis Braces:

CENTER DIFF: REAR:
 BATTERY INNER: BATTERY OUTER:

Tires / Wheels:

BRAND / TREAD: _____
 COMPOUND: _____
 INSERT: _____
 WHEEL: _____
 NOTES: _____

Body / Wing:

BODY MAKE: _____
 WING MAKE: _____

Notes:

Rear End:

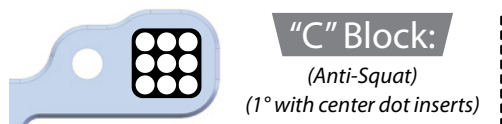
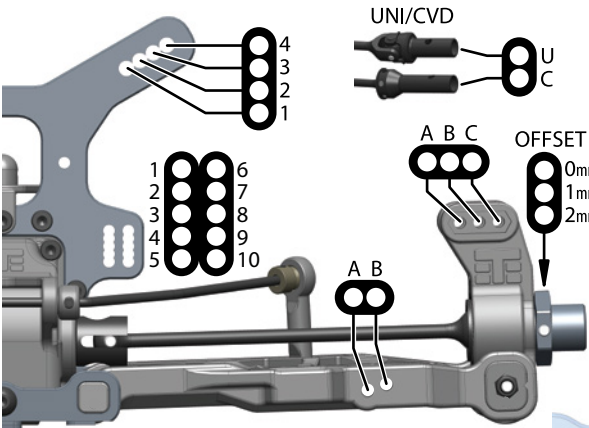

Suspension:

RIDE HEIGHT: _____ CAMBER: _____
 ANTI-SQUAT: _____ TOE: _____
 SWAY BAR: _____ DROOP: _____

Shocks:

OIL: _____ BRAND: _____
 PISTON: _____ SPRING: _____
 REBOUND: _____ BUILD: _____

Arm Inserts:

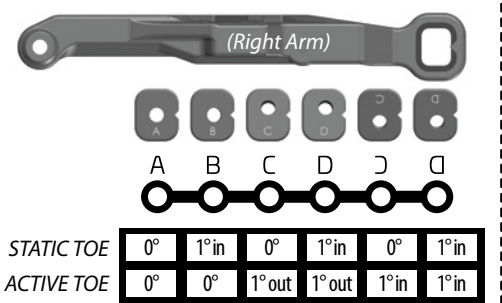

Rear Hub / Wheelbase:

